

Microplate, 96-well 781600

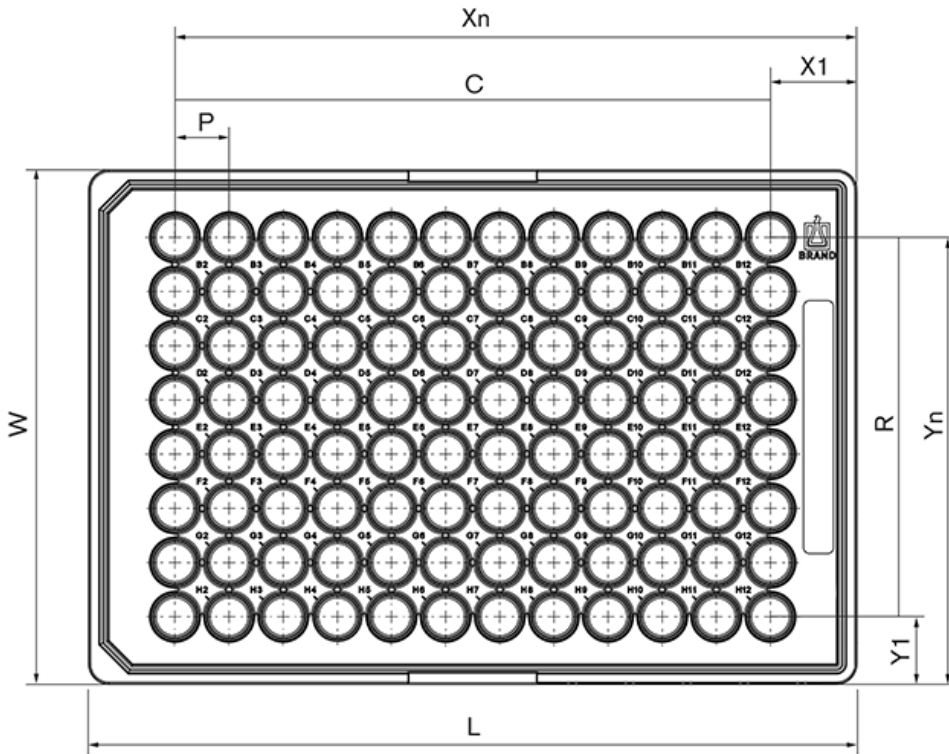

L	127.71 mm
W	85.43 mm
H	14.10 mm
Hs	2.45 mm
X1	14.34 mm
Xn	113.36 mm
Y1	11.22 mm
Yn	74.22 mm
P	9.00 mm
D	6.94 mm
Hw	10.85 mm
C	12 Well
R	8 Well

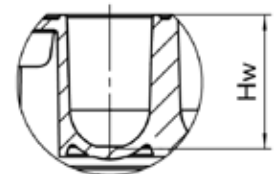
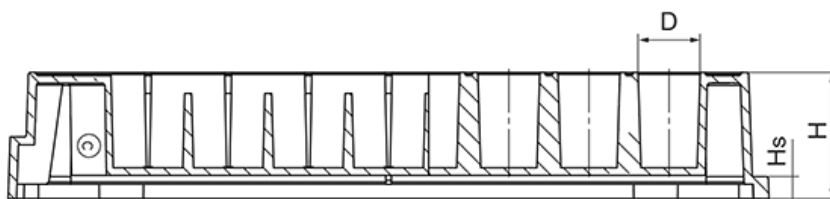

Type	standard
Base shape	U-bottom
Surface	pureGrade™
Volume	330 µl / well
Material	PS
Color	transparent
Quality	Cleanroom class 8 according to ISO 14 644-1, Free of DNA*, RNase and DNase, Free of pyrogens, according to LAL test **, Free of cytotoxic subst. acc. ISO 10 993-5



* human and bacterial DNA, ** according to Limulus Amebocyte Lysate (LAL) test, detection limit 0.01 EU/ml

Subject to technical modification without notice. Errors excepted.

Microplate, 96-well 781601

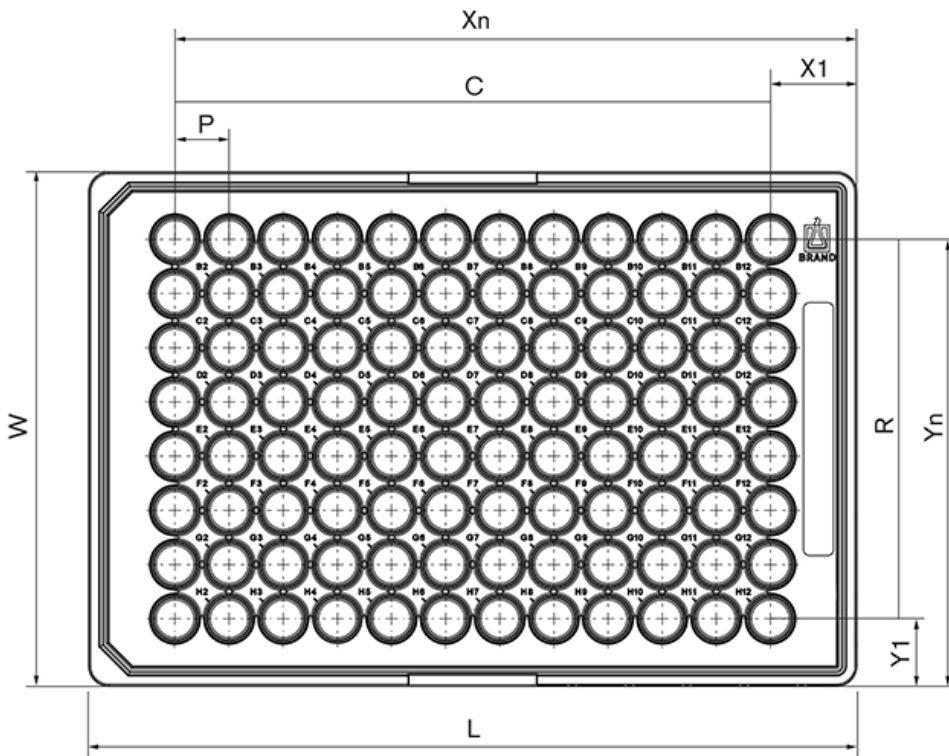

L	127.71 mm
W	85.43 mm
H	14.10 mm
Hs	2.45 mm
X1	14.36 mm
Xn	113.36 mm
Y1	11.22 mm
Yn	74.22 mm
P	9.00 mm
D	6.94 mm
Hw	11.65 mm
C	12 Well
R	8 Well

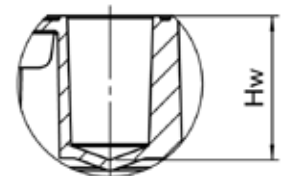
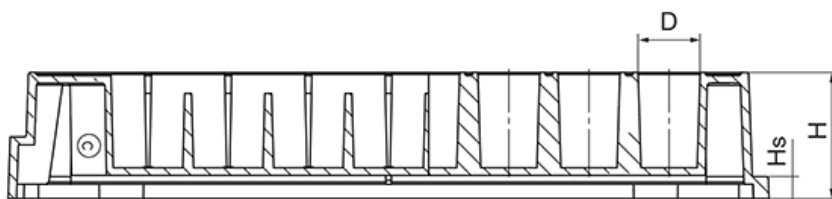

Type	standard
Base shape	V-bottom
Surface	pureGrade™
Volume	360 µl / well
Material	PS
Color	transparent
Quality	Cleanroom class 8 according to ISO 14 644-1, Free of DNA*, RNase and DNase, Free of pyrogens, according to LAL test **, Free of cytotoxic subst. acc. ISO 10 993-5



* human and bacterial DNA, ** according to Limulus Amebocyte Lysate (LAL) test, detection limit 0.01 EU/ml

Subject to technical modification without notice. Errors excepted.

Microplate, 96-well 781602

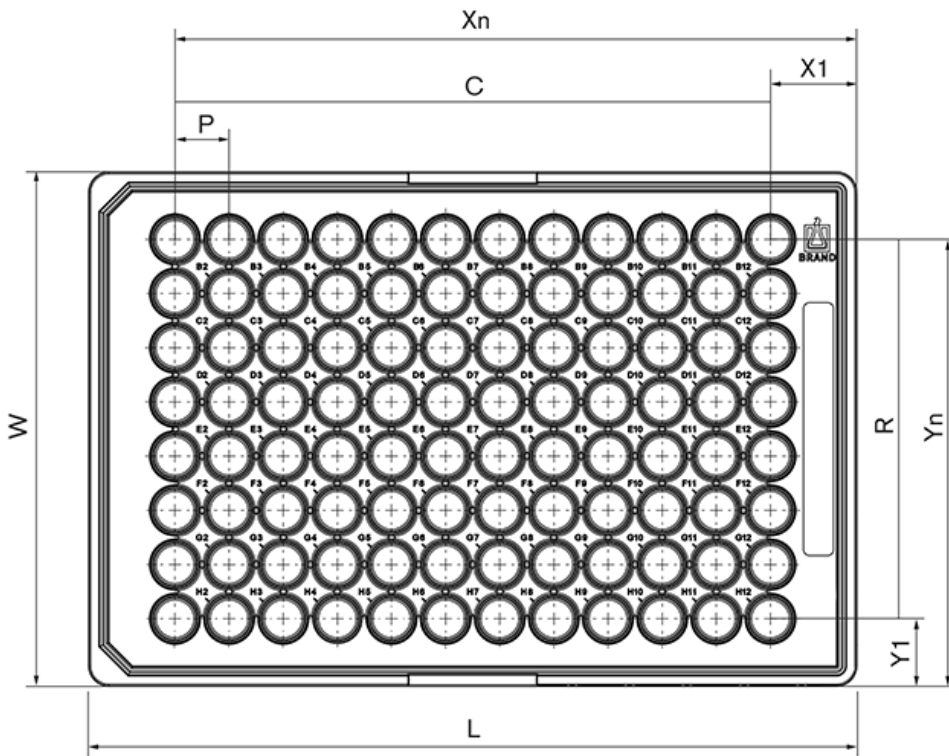

L	127.71 mm
W	85.43 mm
H	14.10 mm
Hs	2.45 mm
X1	14.36 mm
Xn	113.36 mm
Y1	11.22 mm
Yn	74.22 mm
P	9.00 mm
D	6.94 mm
Hw	10.65 mm
C	12 Well
R	8 Well

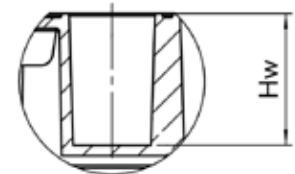
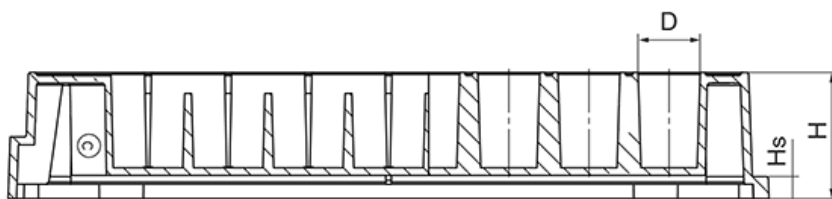

Type	standard
Base shape	F-bottom
Surface	pureGrade™
Volume	350 µl / well
Material	PS
Color	transparent
Quality	Cleanroom class 8 according to ISO 14 644-1, Free of DNA*, RNase and DNase, Free of pyrogens, according to LAL test **, Free of cytotoxic subst. acc. ISO 10 993-5



* human and bacterial DNA, ** according to Limulus Amebocyte Lysate (LAL) test, detection limit 0.01 EU/ml

Subject to technical modification without notice. Errors excepted.

Microplate, 96-well 781603

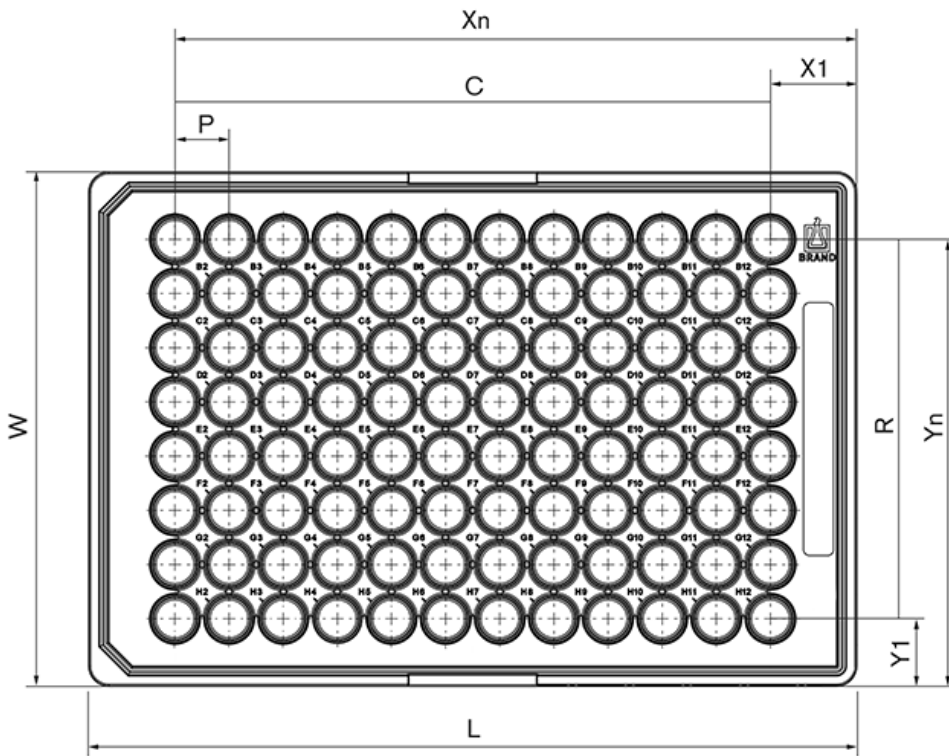

L	127.71 mm
W	85.43 mm
H	14.10 mm
Hs	2.45 mm
X1	14.36 mm
Xn	113.36 mm
Y1	11.22 mm
Yn	74.22 mm
P	9.00 mm
D	6.94 mm
Hw	10.85 mm
C	12 Well
R	8 Well

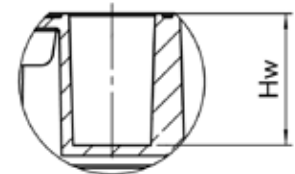
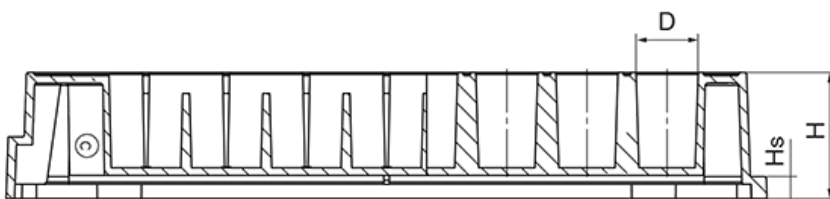

Type	standard
Base shape	C-bottom
Surface	pureGrade™
Volume	350 µl / well
Material	PS
Color	transparent
Quality	Cleanroom class 8 according to ISO 14 644-1, Free of DNA*, RNase and DNase, Free of pyrogens, according to LAL test **, Free of cytotoxic subst. acc. ISO 10 993-5



* human and bacterial DNA, ** according to Limulus Amebocyte Lysate (LAL) test, detection limit 0.01 EU/ml

Subject to technical modification without notice. Errors excepted.

Microplate, 96-well 781604

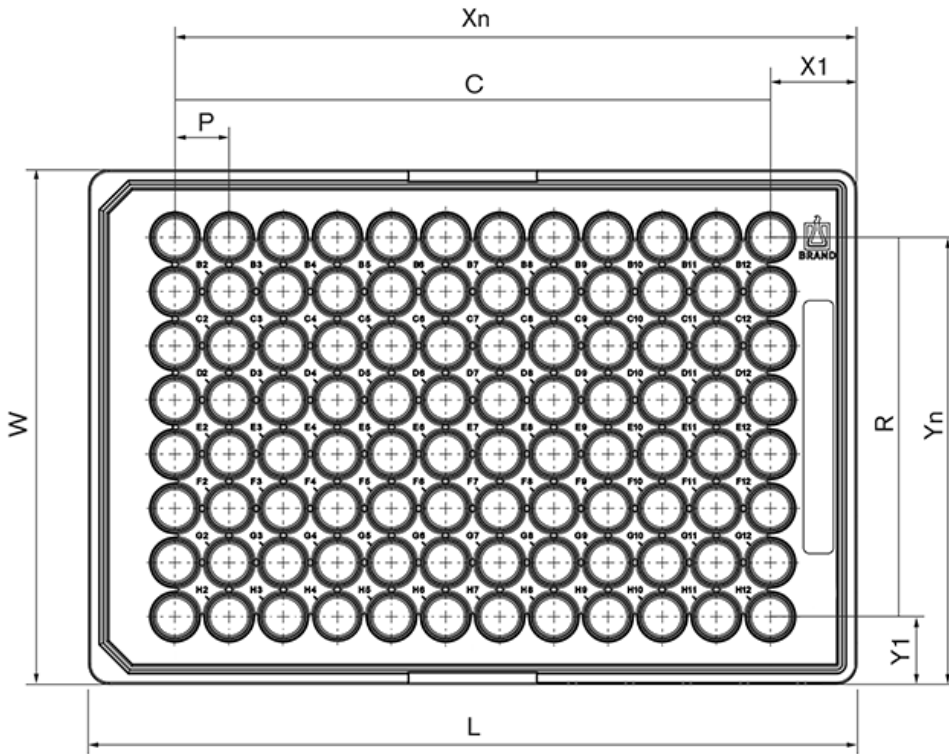

L	127.71 mm
W	85.43 mm
H	14.10 mm
Hs	2.45 mm
X1	14.36 mm
Xn	113.36 mm
Y1	11.22 mm
Yn	74.22 mm
P	9.00 mm
D	6.94 mm
Hw	10.85 mm
C	12 Well
R	8 Well

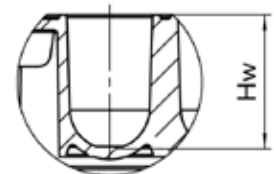
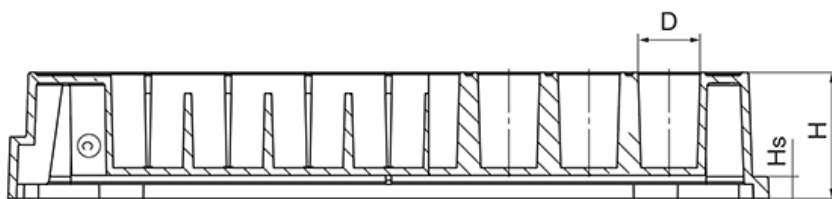

Type	standard
Base shape	U-bottom
Surface	pureGrade™
Volume	330 µl / well
Material	PS
Color	white
Quality	Cleanroom class 8 according to ISO 14 644-1, Free of DNA*, RNase and DNase, Free of pyrogens, according to LAL test **, Free of cytotoxic subst. acc. ISO 10 993-5



* human and bacterial DNA, ** according to Limulus Amebocyte Lysate (LAL) test, detection limit 0.01 EU/ml

Subject to technical modification without notice. Errors excepted.

Microplate, 96-well 781605

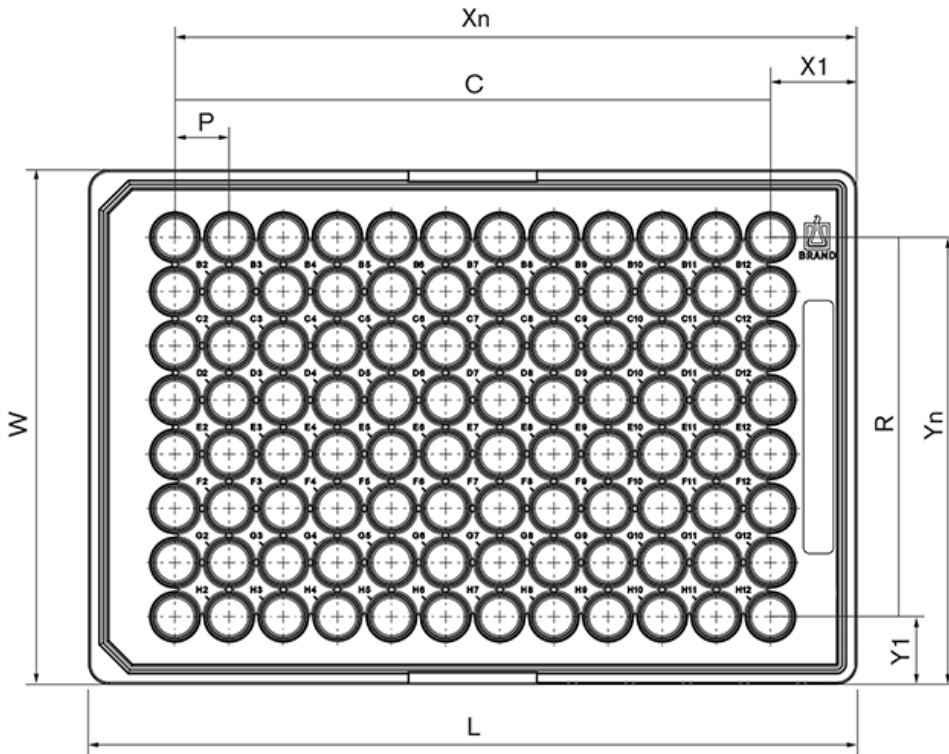

L	127.71 mm
W	85.43 mm
H	14.10 mm
Hs	2.45 mm
X1	14.36 mm
Xn	113.36 mm
Y1	11.22 mm
Yn	74.22 mm
P	9.00 mm
D	6.94 mm
Hw	10.65 mm
C	12 Well
R	8 Well

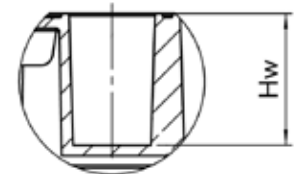
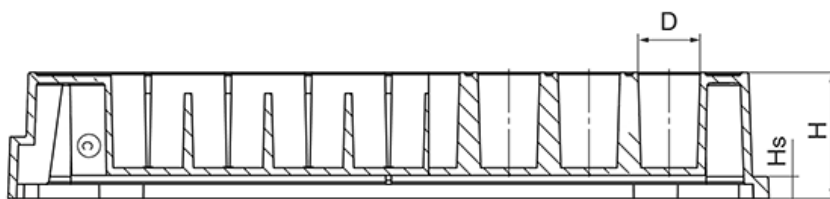

Type	standard
Base shape	F-bottom
Surface	pureGrade™
Volume	350 µl / well
Material	PS
Color	white
Quality	Cleanroom class 8 according to ISO 14 644-1, Free of DNA*, RNase and DNase, Free of pyrogens, according to LAL test **, Free of cytotoxic subst. acc. ISO 10 993-5



* human and bacterial DNA, ** according to Limulus Amebocyte Lysate (LAL) test, detection limit 0.01 EU/ml

Subject to technical modification without notice. Errors excepted.

Microplate, 96-well 781607

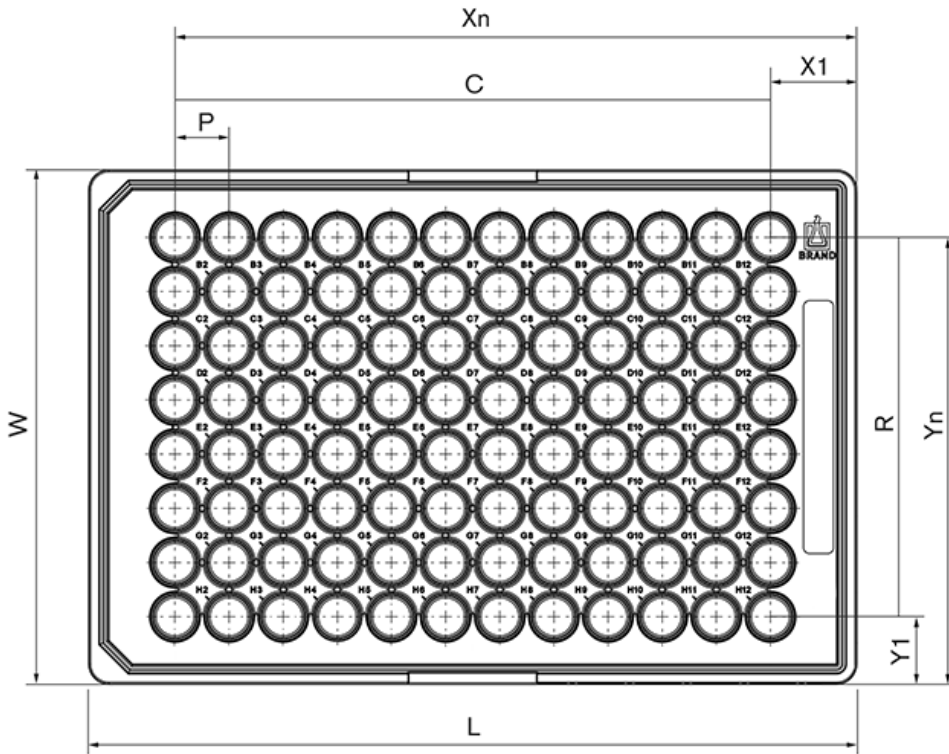

L	127.71 mm
W	85.43 mm
H	14.10 mm
Hs	2.45 mm
X1	14.36 mm
Xn	113.36 mm
Y1	11.22 mm
Yn	74.22 mm
P	9.00 mm
D	6.94 mm
Hw	10.85 mm
C	12 Well
R	8 Well

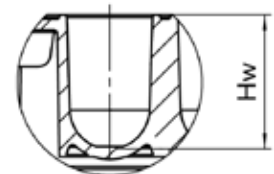
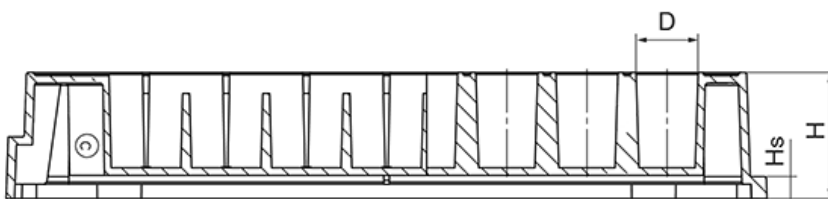

Type	standard
Base shape	U-bottom
Surface	pureGrade™
Volume	330 µl / well
Material	PS
Color	black
Quality	Cleanroom class 8 according to ISO 14 644-1, Free of DNA*, RNase and DNase, Free of pyrogens, according to LAL test **, Free of cytotoxic subst. acc. ISO 10 993-5



* human and bacterial DNA, ** according to Limulus Amebocyte Lysate (LAL) test, detection limit 0.01 EU/ml

Subject to technical modification without notice. Errors excepted.

Microplate, 96-well 781608

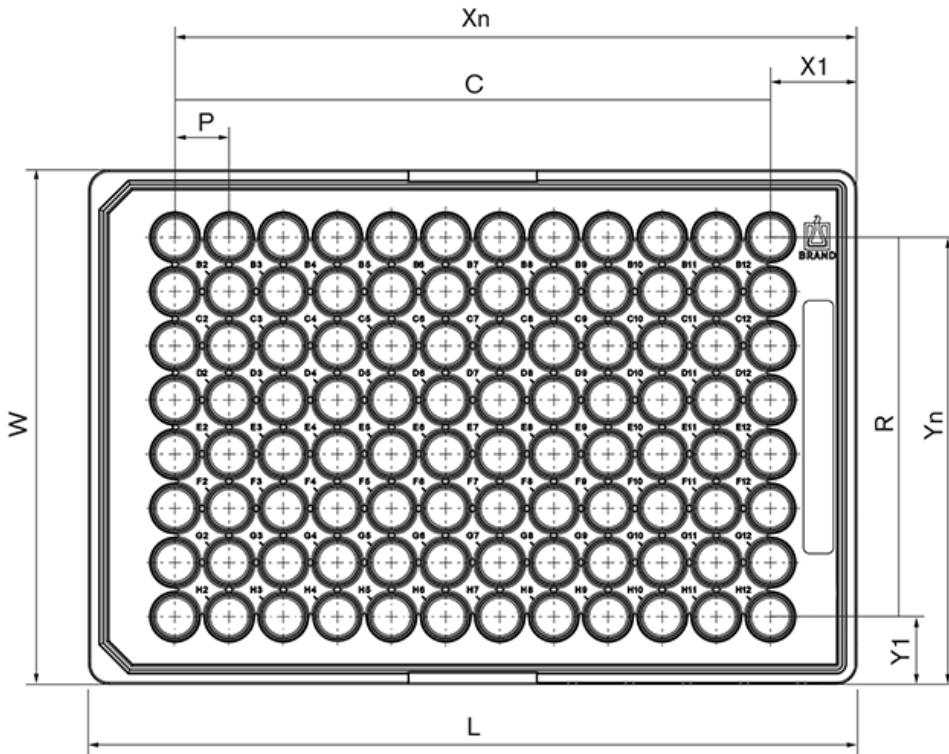

L	127.71 mm
W	85.43 mm
H	14.10 mm
Hs	2.45 mm
X1	14.36 mm
Xn	113.36 mm
Y1	11.22 mm
Yn	74.22 mm
P	9.00 mm
D	6.94 mm
Hw	10.65 mm
C	12 Well
R	8 Well

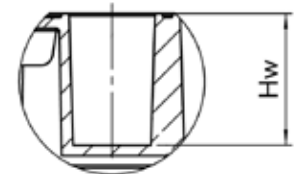
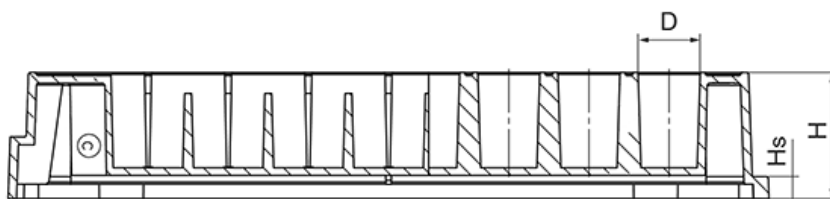

Type	standard
Base shape	F-bottom
Surface	pureGrade™
Volume	350 µl / well
Material	PS
Color	black
Quality	Cleanroom class 8 according to ISO 14 644-1, Free of DNA*, RNase and DNase, Free of pyrogens, according to LAL test **, Free of cytotoxic subst. acc. ISO 10 993-5



* human and bacterial DNA, ** according to Limulus Amebocyte Lysate (LAL) test, detection limit 0.01 EU/ml

Subject to technical modification without notice. Errors excepted.

Microplate, 96-well 781610

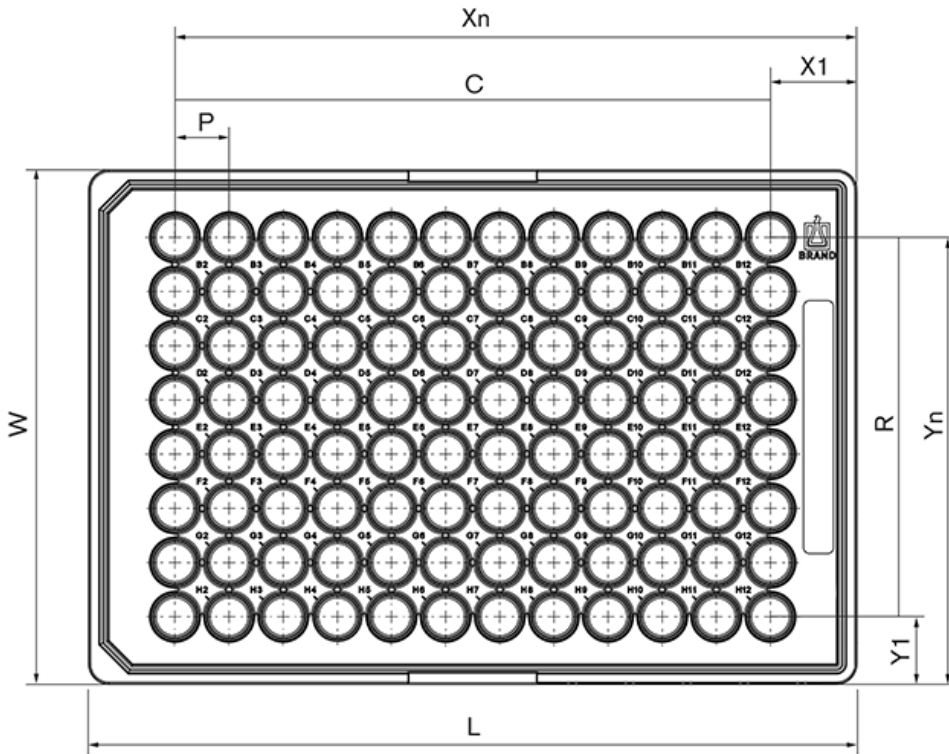

L	127.60 mm
W	85.43 mm
H	14.70 mm
Hs	6.40 mm
X1	14.40 mm
Xn	113.40 mm
Y1	11.50 mm
Yn	74.50 mm
P	9.00 mm
D	6.30 mm
Hw	11.15 mm
C	12 Well
R	8 Well

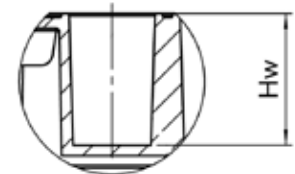
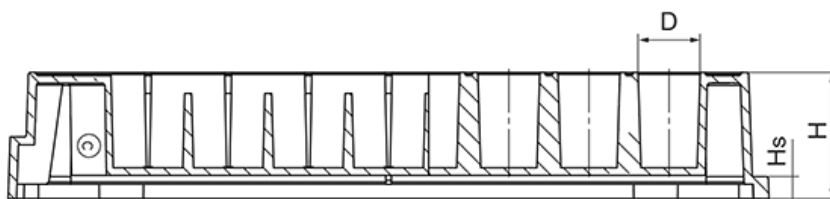

Type	standard, transparent bottom
Base shape	F-bottom
Surface	pureGrade™
Volume	330 µl / well
Material	PS
Color	white
Quality	Cleanroom class 8 according to ISO 14 644-1, Free of DNA*, RNase and DNase, Free of pyrogens, according to LAL test **, Free of cytotoxic subst. acc. ISO 10 993-5



* human and bacterial DNA, ** according to Limulus Amebocyte Lysate (LAL) test, detection limit 0.01 EU/ml

Subject to technical modification without notice. Errors excepted.

Microplate, 96-well 781611

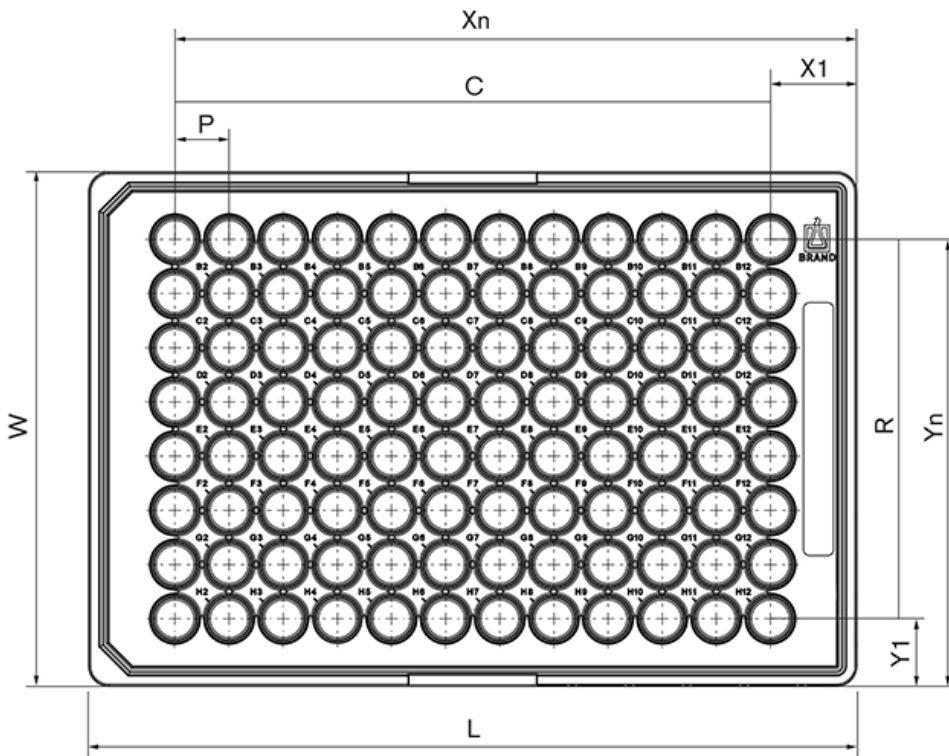

L	127.60 mm
W	85.43 mm
H	14.70 mm
Hs	6.40 mm
X1	14.40 mm
Xn	113.40 mm
Y1	11.50 mm
Yn	74.50 mm
P	9.00 mm
D	6.30 mm
Hw	11.15 mm
C	12 Well
R	8 Well

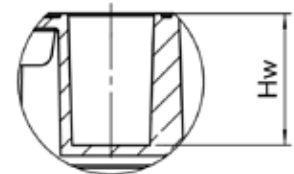
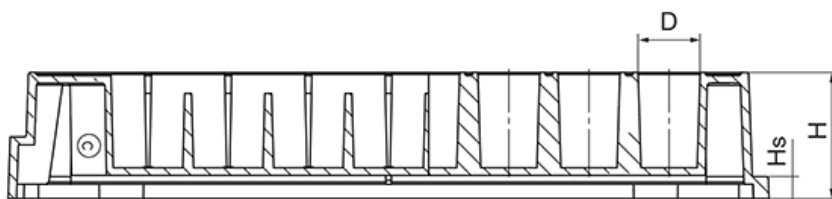

Type	standard, transparent bottom
Base shape	F-bottom
Surface	pureGrade™
Volume	330 µl / well
Material	PS
Color	black
Quality	Cleanroom class 8 according to ISO 14 644-1, Free of DNA*, RNase and DNase, Free of pyrogens, according to LAL test **, Free of cytotoxic subst. acc. ISO 10 993-5



* human and bacterial DNA, ** according to Limulus Amebocyte Lysate (LAL) test, detection limit 0.01 EU/ml

Subject to technical modification without notice. Errors excepted.

Microplate, 96-well 781614

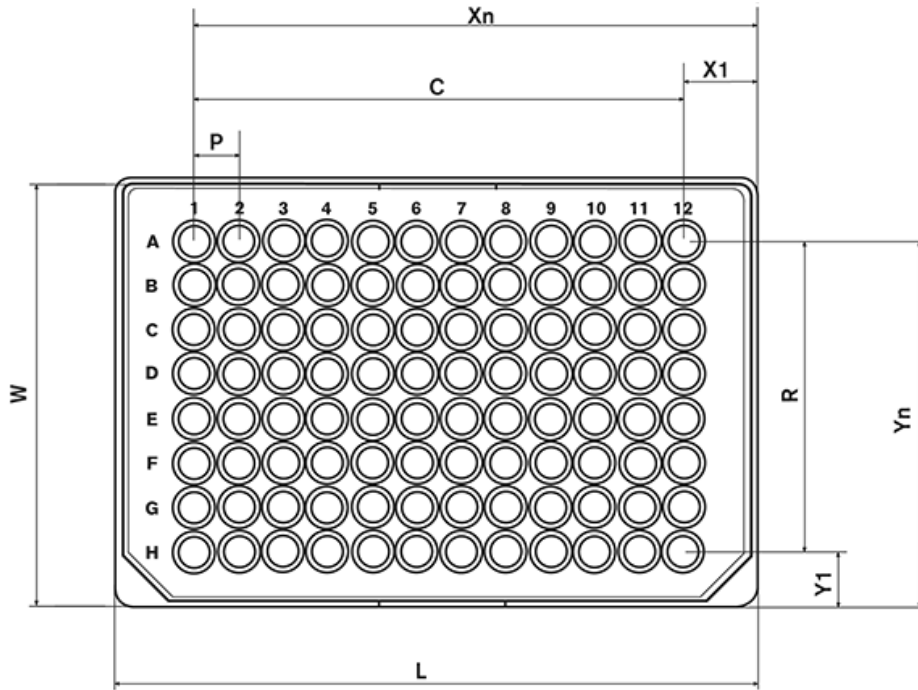

L	127.76 mm
W	85.48 mm
H	14.35 mm
Hs	2.50 mm
X1	14.38 mm
Xn	113.38 mm
Y1	11.24 mm
Yn	74.24 mm
P	9.00 mm
D	6.50 mm
Hw	13.50 mm
C	12 Well
R	8 Well

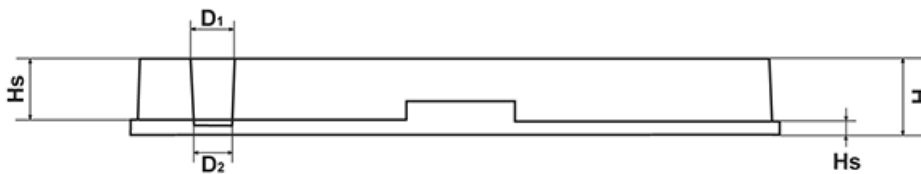

Type	standard, bottom UV-transparent
Base shape	F-bottom
Surface	pureGrade™
Volume	428 µl / well
Material	PS
Color	transparent
Quality	Cleanroom class 8 according to ISO 14 644-1, Free of DNA*, RNase and DNase, Free of pyrogens, according to LAL test **, Free of cytotoxic subst. acc. ISO 10 993-5



* human and bacterial DNA, ** according to Limulus Amebocyte Lysate (LAL) test, detection limit 0.01 EU/ml

Subject to technical modification without notice. Errors excepted.

Microplate, 96-well 781615

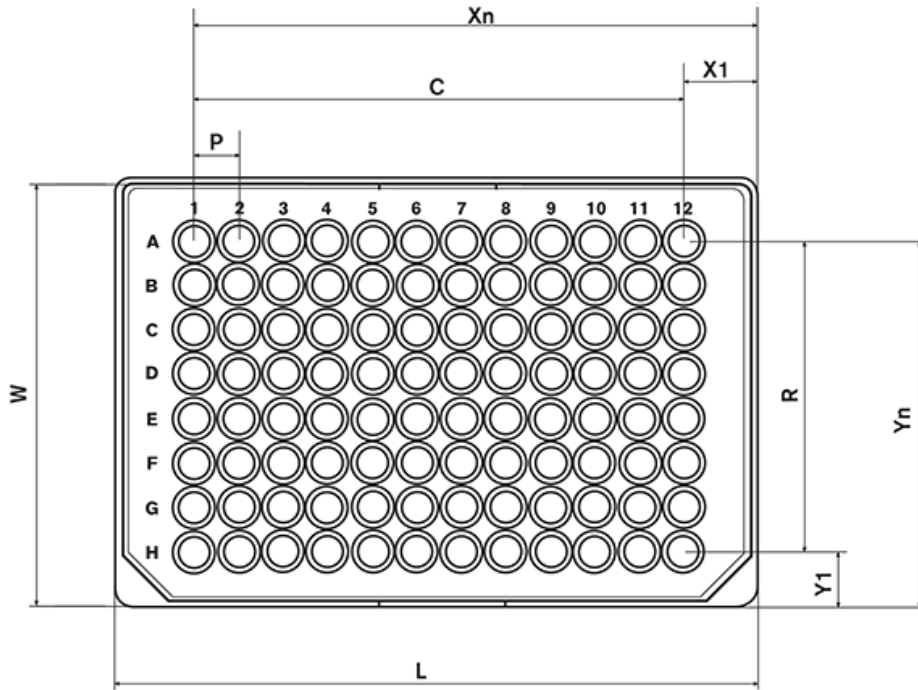

L	127.76 mm
W	85.48 mm
H	14.35 mm
Hs	2.50 mm
X1	14.38 mm
Xn	113.38 mm
Y1	11.24 mm
Yn	74.24 mm
P	9.00 mm
D	6.50 mm
Hw	13.50 mm
C	12 Well
R	8 Well

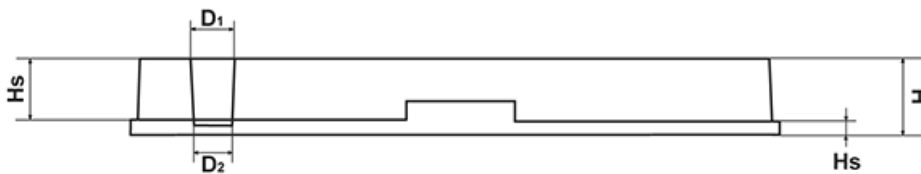

Type	standard, bottom UV-transparent
Base shape	F-bottom
Surface	pureGrade™
Volume	428 µl / well
Material	PS
Color	black
Quality	Cleanroom class 8 according to ISO 14 644-1, Free of DNA*, RNase and DNase, Free of pyrogens, according to LAL test **, Free of cytotoxic subst. acc. ISO 10 993-5



* human and bacterial DNA, ** according to Limulus Amebocyte Lysate (LAL) test, detection limit 0.01 EU/ml

Subject to technical modification without notice. Errors excepted.