

Microplate, 96-well 781660

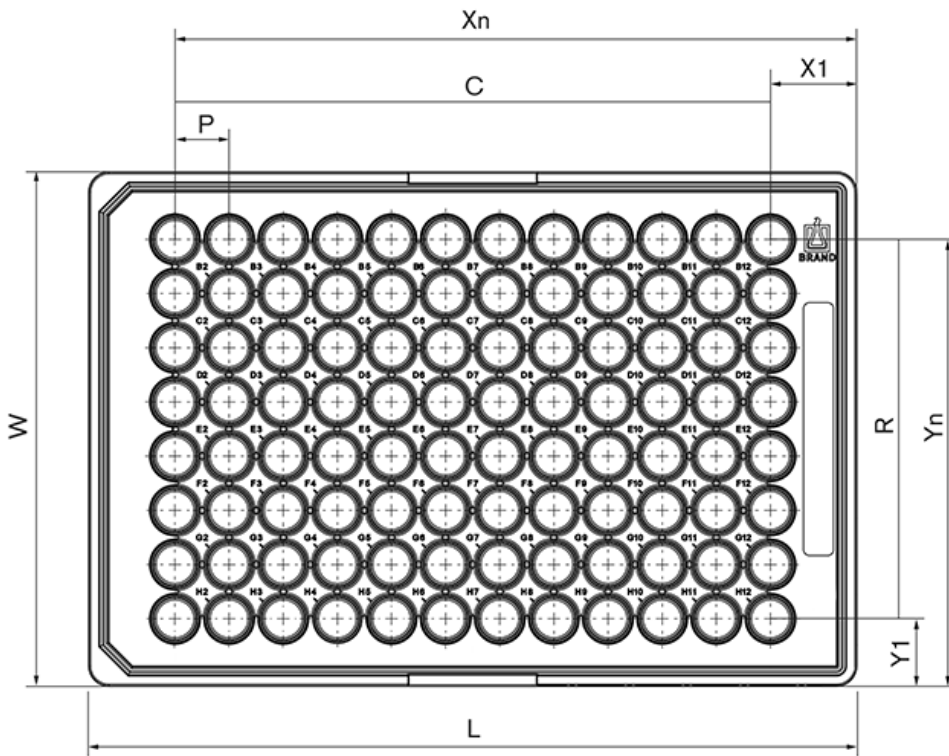

L	127.71 mm
W	85.43 mm
H	14.10 mm
Hs	2.45 mm
X1	14.34 mm
Xn	113.36 mm
Y1	11.22 mm
Yn	74.22 mm
P	9.00 mm
D	6.94 mm
Hw	10.85 mm
C	12 Well
R	8 Well

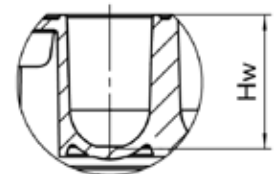
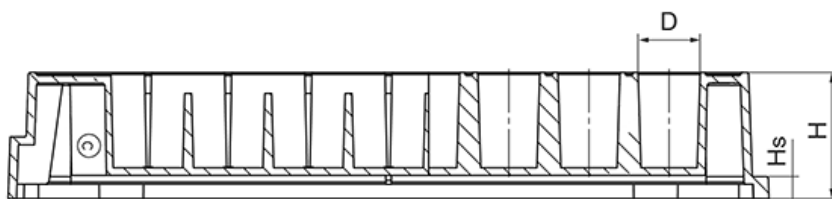

Type	standard
Base shape	U-bottom
Surface	pureGrade™ S
Volume	330 µl / well
Material	PS
Color	transparent
Quality	Cleanroom class 8 according to ISO 14 644-1, Free of DNA*, RNase and DNase, Free of pyrogens, according to LAL test **



* human and bacterial DNA, ** according to Limulus Amebocyte Lysate (LAL) test, detection limit 0.01 EU/ml

Subject to technical modification without notice. Errors excepted.

Microplate, 96-well 781661

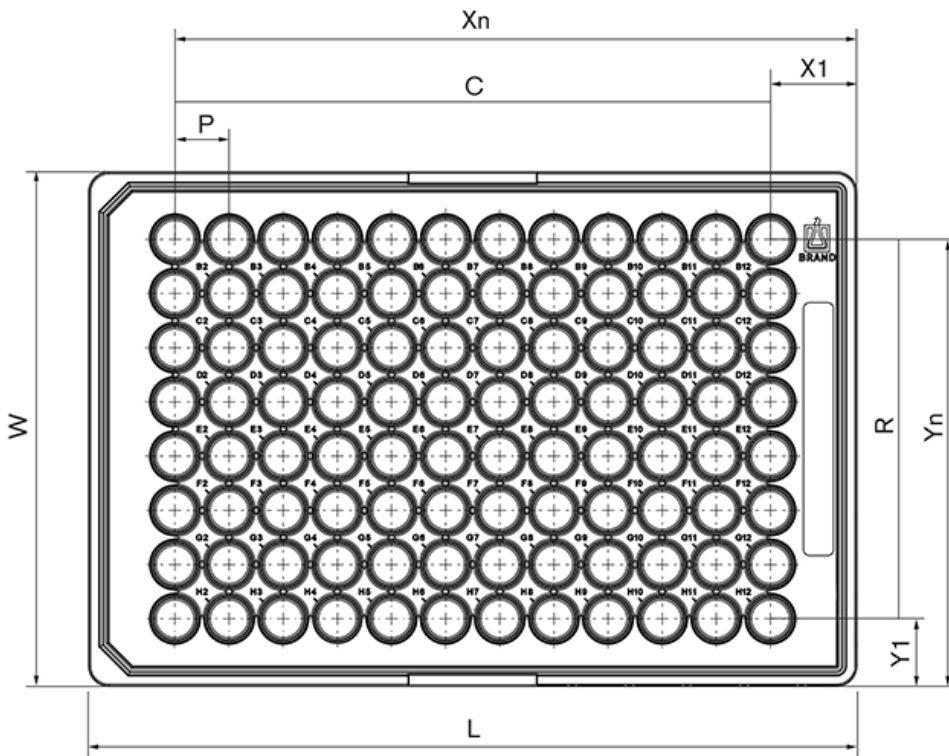

L	127.71 mm
W	85.43 mm
H	14.10 mm
Hs	2.45 mm
X1	14.36 mm
Xn	113.36 mm
Y1	11.22 mm
Yn	74.22 mm
P	9.00 mm
D	6.94 mm
Hw	11.65 mm
C	12 Well
R	8 Well

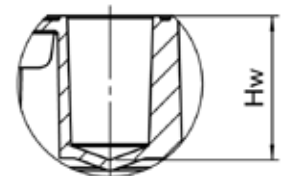
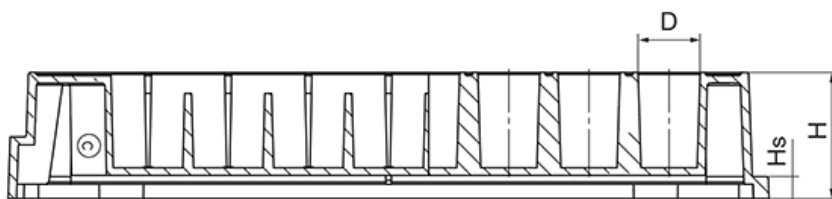

Type	standard
Base shape	V-bottom
Surface	pureGrade™ S
Volume	360 µl / well
Material	PS
Color	transparent
Quality	Cleanroom class 8 according to ISO 14 644-1, Free of DNA*, RNase and DNase, Free of pyrogens, according to LAL test **



* human and bacterial DNA, ** according to Limulus Amebocyte Lysate (LAL) test, detection limit 0.01 EU/ml

Subject to technical modification without notice. Errors excepted.

Microplate, 96-well 781662

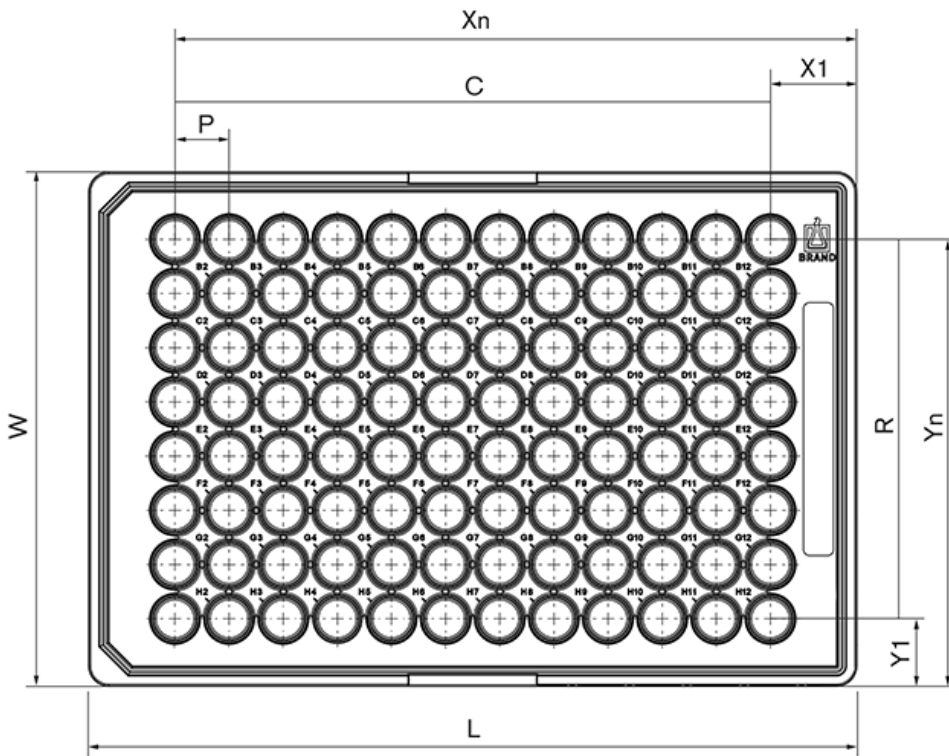

L	127.71 mm
W	85.43 mm
H	14.10 mm
Hs	2.45 mm
X1	14.36 mm
Xn	113.36 mm
Y1	11.22 mm
Yn	74.22 mm
P	9.00 mm
D	6.94 mm
Hw	10.65 mm
C	12 Well
R	8 Well

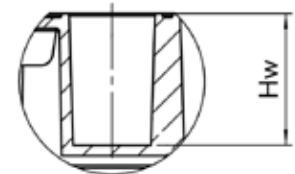
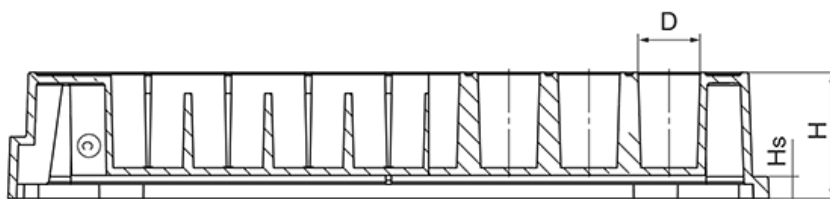

Type	standard
Base shape	F-bottom
Surface	pureGrade™ S
Volume	350 µl / well
Material	PS
Color	transparent
Quality	Cleanroom class 8 according to ISO 14 644-1, Free of DNA*, RNase and DNase, Free of pyrogens, according to LAL test **



* human and bacterial DNA, ** according to Limulus Amebocyte Lysate (LAL) test, detection limit 0.01 EU/ml

Subject to technical modification without notice. Errors excepted.

Microplate, 96-well 781663

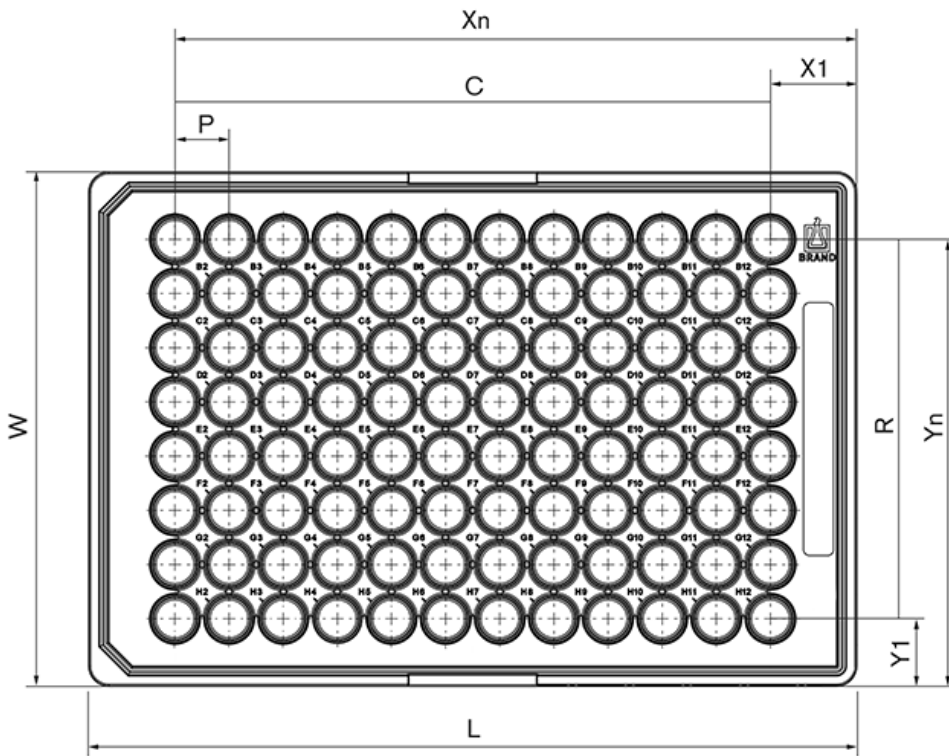

L	127.71 mm
W	85.43 mm
H	14.10 mm
Hs	2.45 mm
X1	14.36 mm
Xn	113.36 mm
Y1	11.22 mm
Yn	74.22 mm
P	9.00 mm
D	6.94 mm
Hw	10.85 mm
C	12 Well
R	8 Well

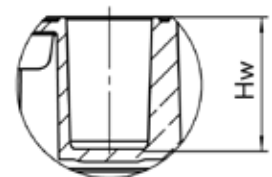
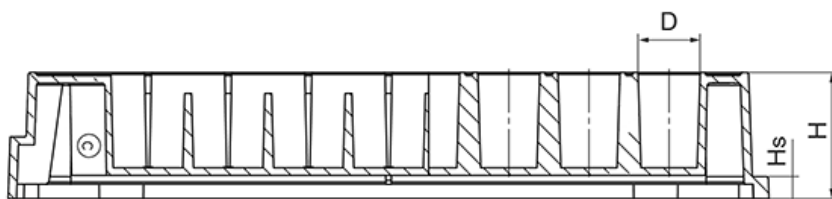

Type	standard
Base shape	C-bottom
Surface	pureGrade™ S
Volume	350 µl / well
Material	PS
Color	transparent
Quality	Cleanroom class 8 according to ISO 14 644-1, Free of DNA*, RNase and DNase, Free of pyrogens, according to LAL test **



* human and bacterial DNA, ** according to Limulus Amebocyte Lysate (LAL) test, detection limit 0.01 EU/ml

Subject to technical modification without notice. Errors excepted.

Microplate, 96-well

781665

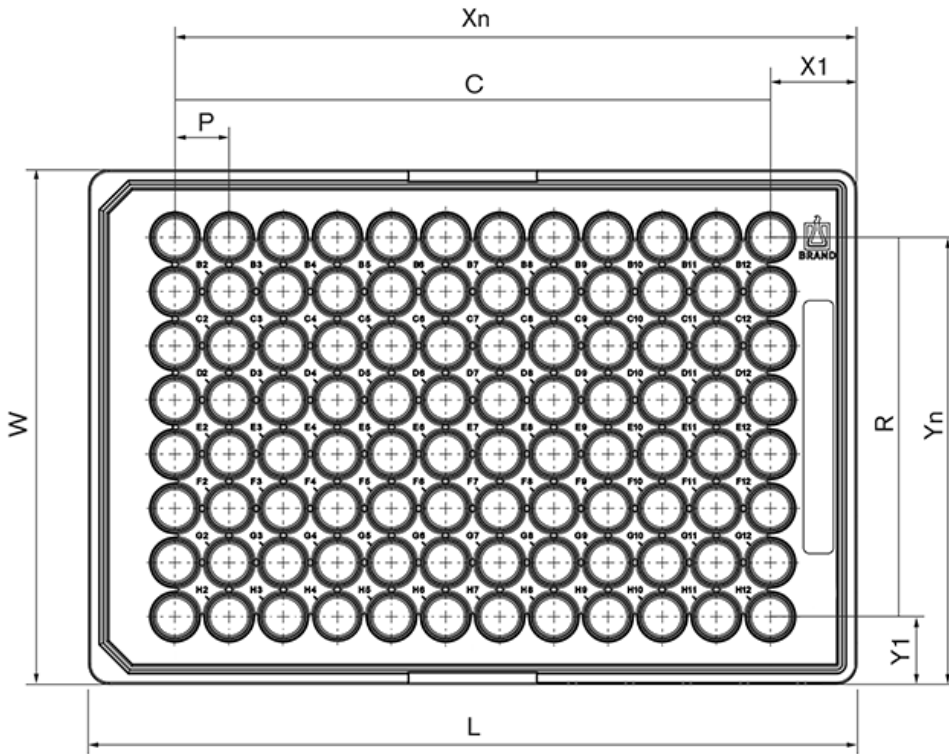

L	127.71 mm
W	85.43 mm
H	14.10 mm
Hs	2.45 mm
X1	14.36 mm
Xn	113.36 mm
Y1	11.22 mm
Yn	74.22 mm
P	9.00 mm
D	6.94 mm
Hw	10.65 mm
C	12 Well
R	8 Well

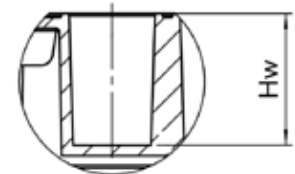
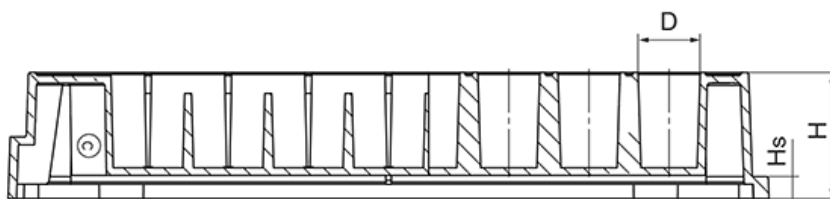

Type	standard
Base shape	F-bottom
Surface	pureGrade™ S
Volume	350 µl / well
Material	PS
Color	white
Quality	Cleanroom class 8 according to ISO 14 644-1, Free of DNA*, RNase and DNase, Free of pyrogens, according to LAL test **



* human and bacterial DNA, ** according to Limulus Amebocyte Lysate (LAL) test, detection limit 0.01 EU/ml

Subject to technical modification without notice. Errors excepted.

Microplate, 96-well 781668

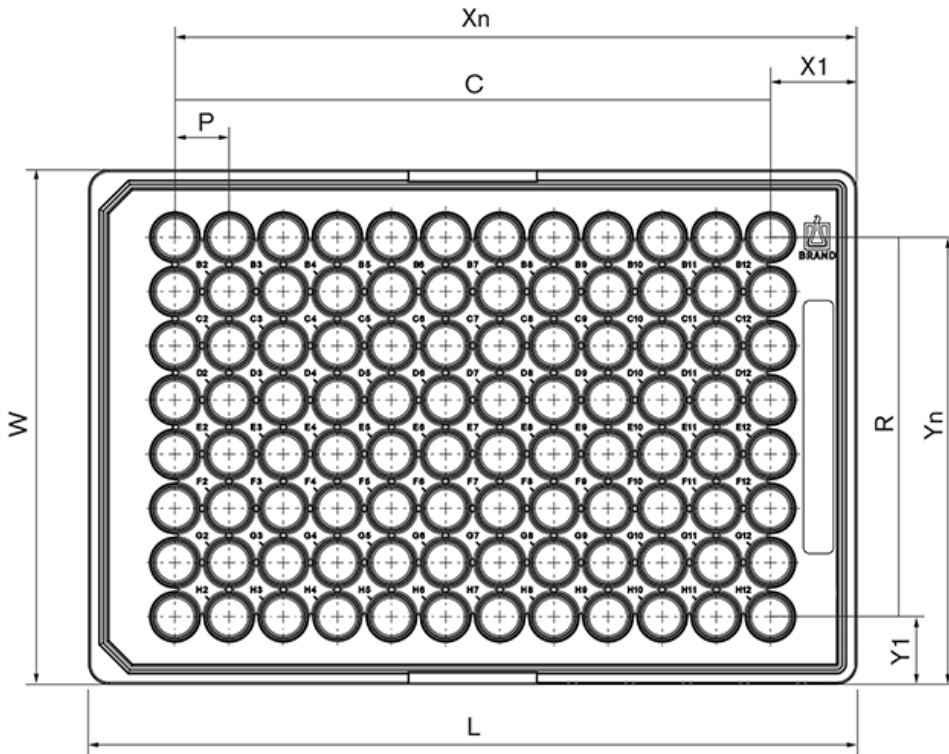

L	127.71 mm
W	85.43 mm
H	14.10 mm
Hs	2.45 mm
X1	14.36 mm
Xn	113.36 mm
Y1	11.22 mm
Yn	74.22 mm
P	9.00 mm
D	6.94 mm
Hw	10.65 mm
C	12 Well
R	8 Well

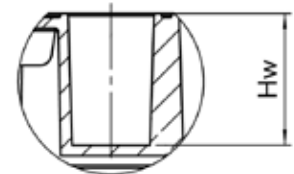
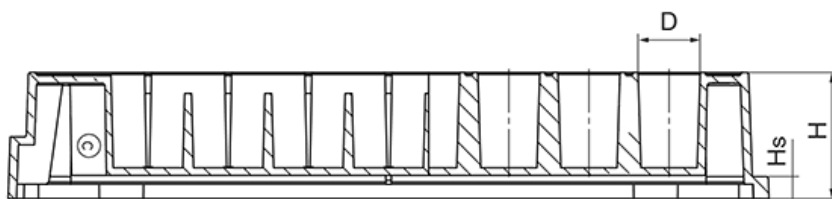

Type	standard
Base shape	F-bottom
Surface	pureGrade™ S
Volume	350 µl / well
Material	PS
Color	black
Quality	Cleanroom class 8 according to ISO 14 644-1, Free of DNA*, RNase and DNase, Free of pyrogens, according to LAL test **



* human and bacterial DNA, ** according to Limulus Amebocyte Lysate (LAL) test, detection limit 0.01 EU/ml

Subject to technical modification without notice. Errors excepted.

Microplate, 96-well 781670

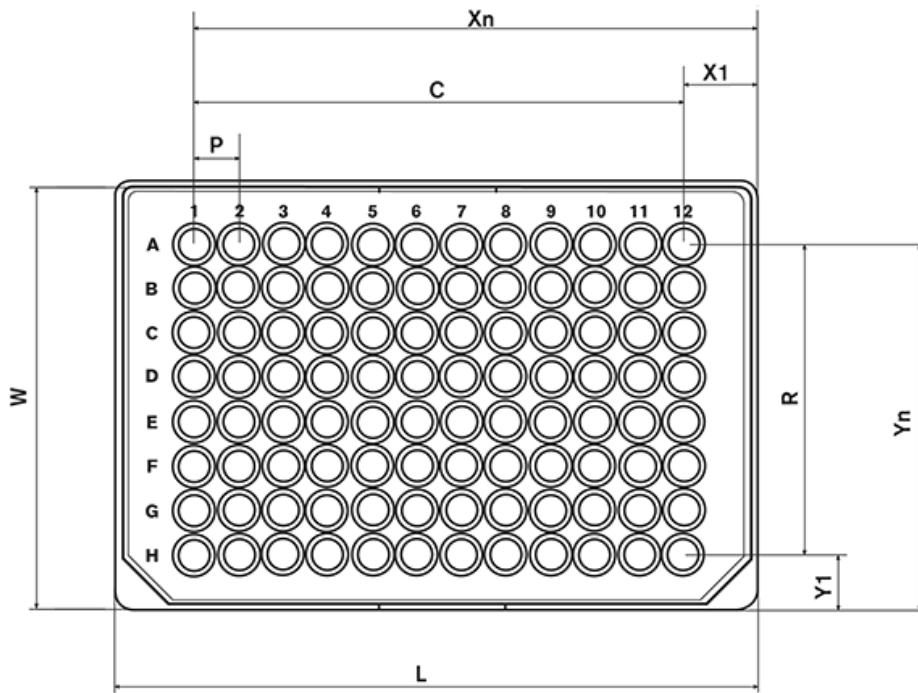

L	127.76 mm
W	85.60 mm
H	14.70 mm
Hs	6.40 mm
X1	14.40 mm
Xn	113.40 mm
Y1	11.50 mm
Yn	74.50 mm
P	9.00 mm
D	6.30 mm
Hw	11.15 mm
C	12 Well
R	8 Well

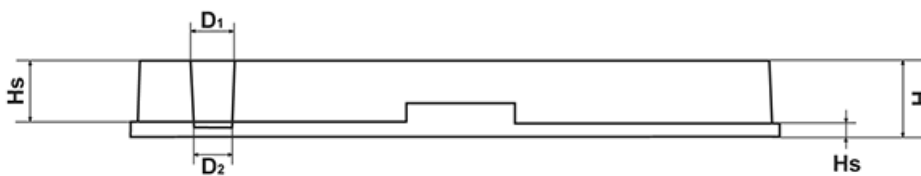

Type	standard, transparent bottom
Base shape	F-bottom
Surface	pureGrade™ S
Volume	330 µl / well
Material	PS
Color	white
Quality	Cleanroom class 8 according to ISO 14 644-1, Free of DNA*, RNase and DNase, Free of pyrogens, according to LAL test **



* human and bacterial DNA, ** according to Limulus Amebocyte Lysate (LAL) test, detection limit 0.01 EU/ml

Subject to technical modification without notice. Errors excepted.

Microplate, 96-well 781671

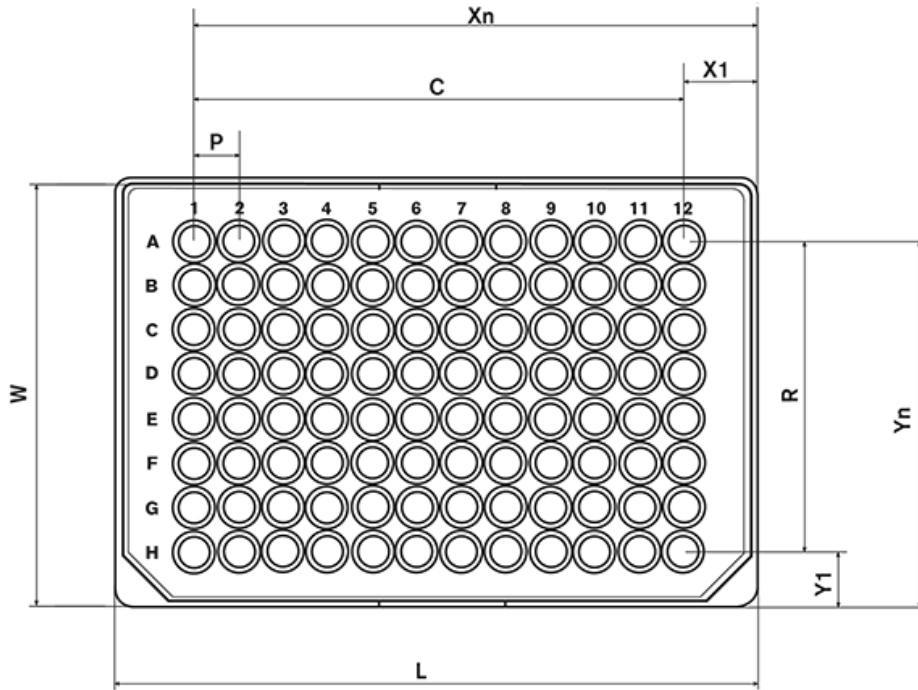

L	127.76 mm
W	85.60 mm
H	14.70 mm
Hs	6.40 mm
X1	14.40 mm
Xn	113.40 mm
Y1	11.50 mm
Yn	74.50 mm
P	9.00 mm
D	6.30 mm
Hw	11.15 mm
C	12 Well
R	8 Well

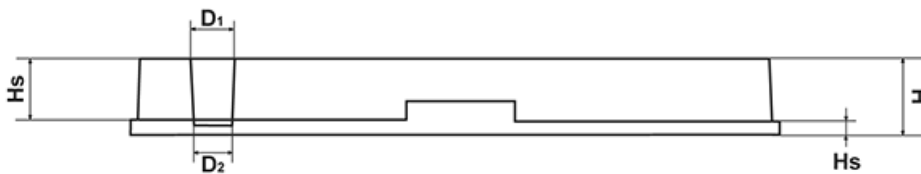

Type	standard, transparent bottom
Base shape	F-bottom
Surface	pureGrade™ S
Volume	330 µl / well
Material	PS
Color	black
Quality	Cleanroom class 8 according to ISO 14 644-1, Free of DNA*, RNase and DNase, Free of pyrogens, according to LAL test **



* human and bacterial DNA, ** according to Limulus Amebocyte Lysate (LAL) test, detection limit 0.01 EU/ml

Subject to technical modification without notice. Errors excepted.